

NO.	NAME	MATERIAL
1	HOUSING	PBT / Nylon
2	PIN TERM.	PHOS. BRONZE
3	SHELL	BRASS

SUA-110M***

Series _____
 Type _____
 Color _____
 B : Black
 W : White

Shell _____
 N : Nickel Plated
 T : Tin Plated
 F : SPCC

Version _____
 1 : 1.1(1~3u")
 2 : 2.0(30u ± 5%)

Material _____
 B : PBT
 P : Nylon

REV	ZONE	REVISION	DATE	APPD.

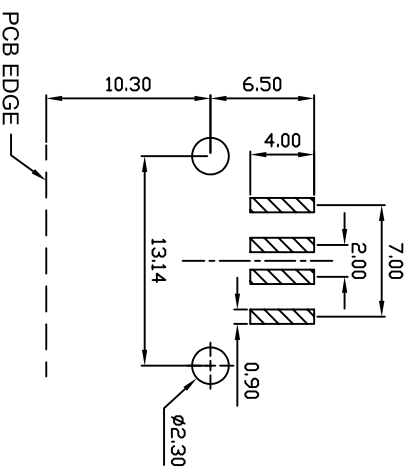
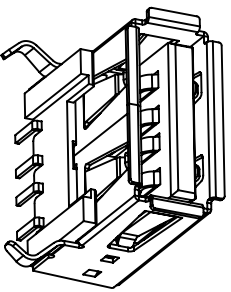
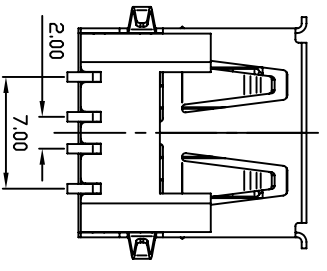
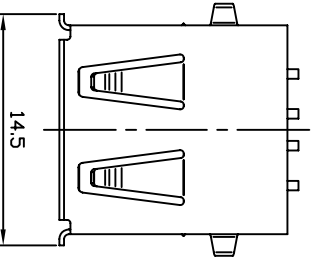

SUGGESTED PCB LAYOUT
TOP VIEW

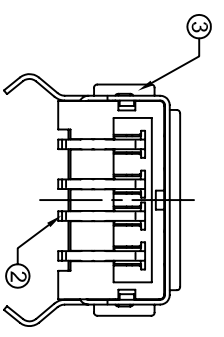
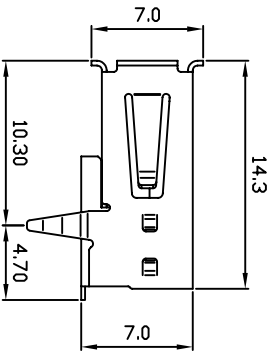
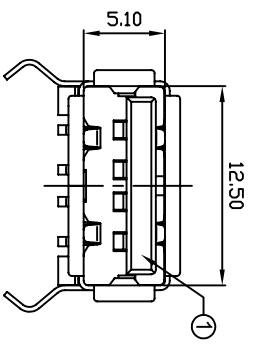

APPROVED BY
KINSWOOD ELECTRONICS CORP.

COMPUTER NO. _____ UNIT _____ SCALE _____ PART NAME _____
 USB, TYPE A
 FLAT 90° SMT

APPD. CKD. DWG. DATE TOLERANCE

MODEL SUA-110M*** PAGE 1 OF 1 Michael Valiant 2007-06-07

0.000mm ± 0.075mm
 0.00 mm ± 0.15 mm
 0.0 mm ± 0.25 mm

REV. A.0